

FlowGrill... A combination of functionality and design

Our knowledge is to design, develop and manufacture tailor made products in turnkey projects. With our many years of experience realizing high-end ventilation louvers and other tailor made solutions, we meet the expectations of our clients from all over the world.

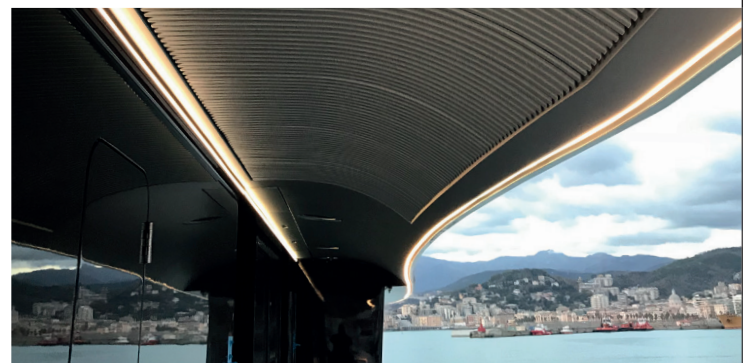
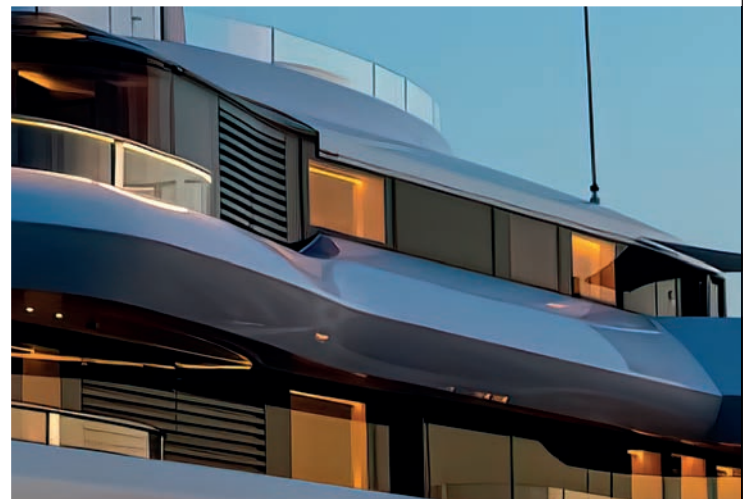
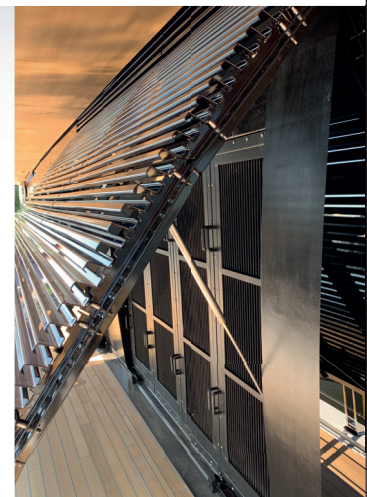

TOP END COMPOSITE EQUIPMENT

SPECIALIST COMPOSITE TECHNOLOGIES



Turn-key yacht solutions
A pleasant feeling!

COMPOSITE TECHNOLOGIES

FlowGrill has a range of composite grills, fins, tubes and much more to complement the product range.

The use of composite materials offers a high degree of design freedom and is suitable for all new build and refit projects!

Custom shaped composite or simple straight designs - Many prestigious yachts from various construction years sail the ocean with FlowGrill composite solutions. Who's next...?

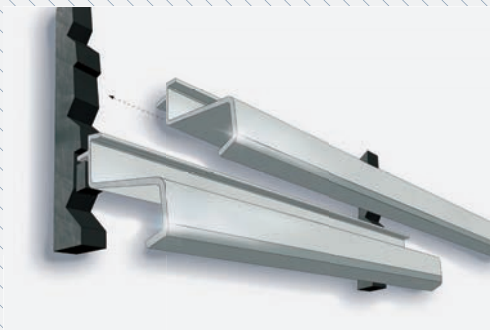

THE SAME LOUVER SOLUTION IN COMPOSITE AND ALUMINIUM EXTRUSION

Existing ventilation grills can be exchanged for composite versions while preserving the design, or by request in a design upgrade. When using standard composite lamellas, short delivery times can be achieved to serve refit projects the best way.

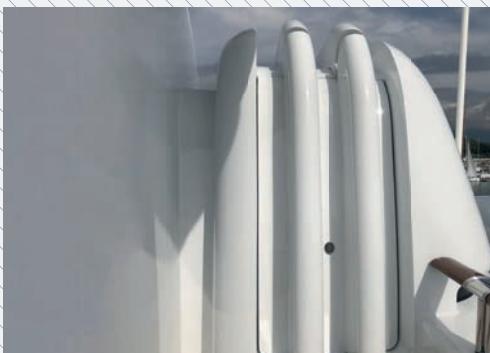

SPECIALIZED COMPOSITE TECHNOLOGIES

Unlimited design possibilities. FlowGrill has extensive experience in composite materials and its processing. This results in eye-catching projects that meet the highest yacht building and owners demands.

From composite ventilation grills and tubes to automatic sun shade lamellas and more. Name it and challenge us!

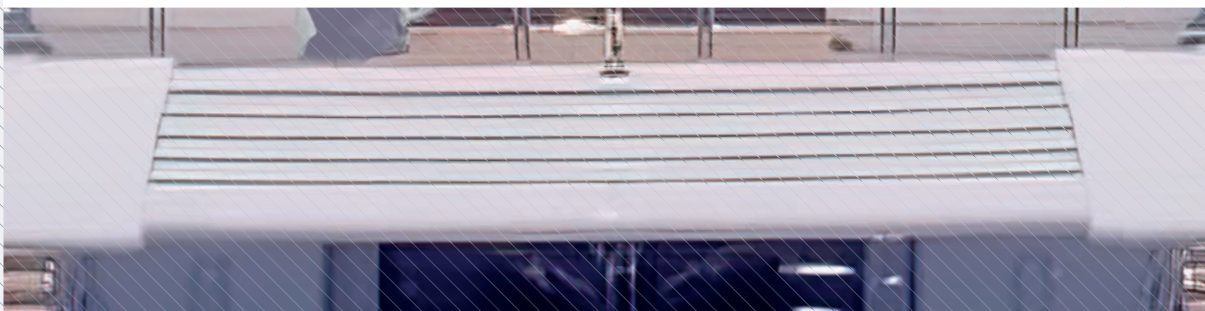

FlowGrill has proven to provide excellent service and quality and will continue this reputation with new innovative products as well.

WIRE MESH FILTER

PREVENTING INCOMING WATER, SALT, DUST AND DIRT

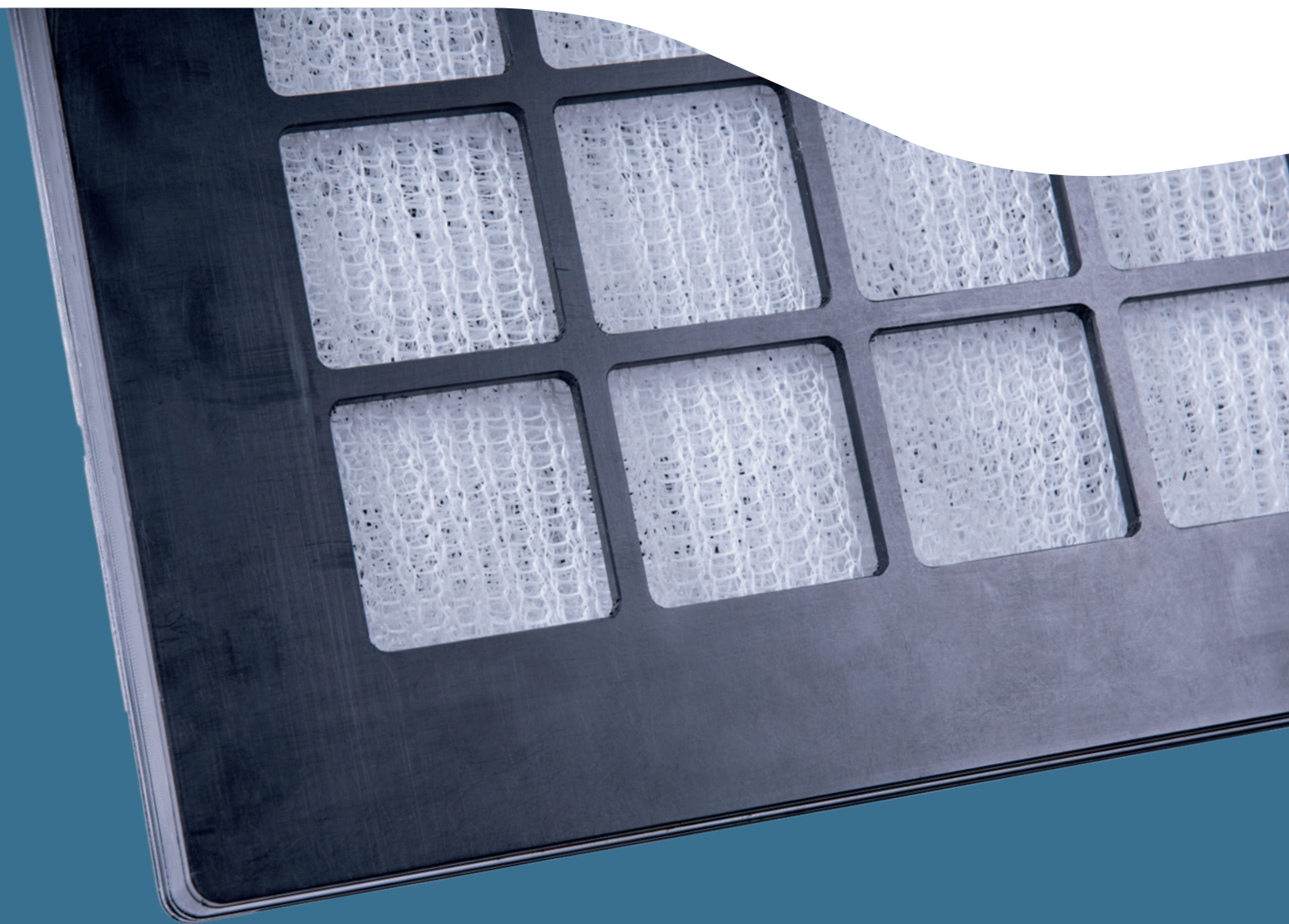

Functional and stylish tailormade yacht solutions

Handelsdwarsstraat 2
6905 DJ Zevenaar
The Netherlands
T: +31 316 23 80 20
E: info@flowgrill.com
W: www.flowgrill.com

Installing a FlowGrill Wire Mesh Filter behind ventilation louvers prevents water, salt, dust and dirt penetration. The collected water is drained away through the built-in drainage system. The FlowGrill Wire Mesh Filter also offer maximum resistance to penetration by dust and dirt. Available in combination with the FlowGrill ventilation louvers and mounting frames, or as a separate component for both new-built and retrofit projects. Simple installation/removal from the outside means extra convenience in applications where frequent maintenance is required.

PROPERTIES

- resistant to water penetration
- dust and dirt resistant
- lightweight
- constructed entirely of plastic
- salt-water resistant
- UV resistant
- long lasting
- various mounting options
- large variety of shapes
- simple installation/removal from the outside
- can be cleaned with water
- light- or heavy duty versions
- can be supplied with test report
- available in combination with ventilation louvers
- drainage, by means of holes (option by pipe)
- frame in black or white

SHAPE, DIMENSIONS, WEIGHT

Shapes according to customer specifications.

Material: constructed entirely of salt-water resistant plastic.

Thickness: 32mm (DL), 37mm (DH).

Frame: cassette or flange type

Weight: depends on size and fill configuration (approx. 8 kg/m²).

OPERATION, MAINTENANCE

The filling can be cleaned with water. The Wire Mesh filter is easily removable.

CONSTRUCTION

Plastic frame assembly. Filling, available in various fill configurations depending on the specified air velocity

APPEARANCE

Plastic lattice frame, smooth finish

MECHANICAL PROPERTIES

Salt-water resistant, UV resistant.

Available with test report and pressure/air velocity curve. Suitable for low and high air velocities.

APPLICATION, DESIGN

Yacht-building, engine rooms, air conditioning, air inlets/outlets (various other air supply systems). Method of mounting depends on frame and possible use in combination with FlowGrill ventilation louver and subframe

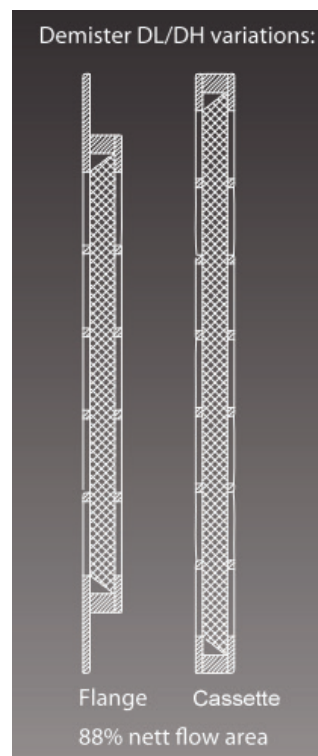

MIST ELIMINATOR

MARINE AIR INTAKE SEPARATION SYSTEM

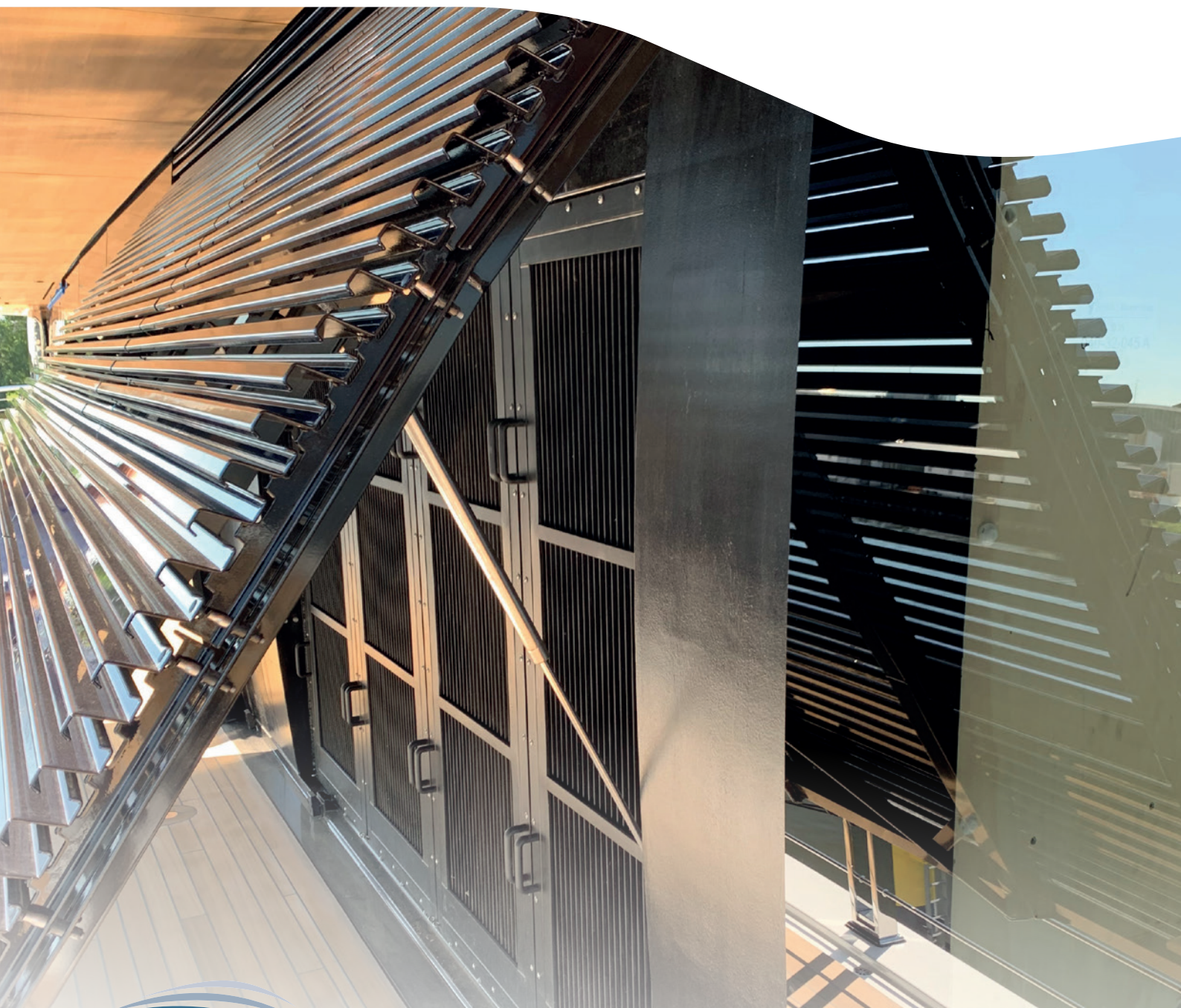

Functional and stylish tailormade yacht solutions

Handelsdwarsstraat 2
6905 DJ Zevenaar
The Netherlands
T: +31 316 23 80 20
E: info@flowgrill.com
W: www.flowgrill.com

The FlowGrill full plastic Mist Eliminator is an Air Intake Separation System for marine applications.

Mainly applied at Engine & generator rooms, Fresh air intakes, etc.

- to eliminate (extremely high) incoming water loads.
- specially designed for high filtration capacities at low and high air speeds.
- to prevent incoming salt, sand, boat wash and other contaminants
- to prevent malfunctions of electronics / computers
- to prevent corrosion



In combination with the FlowGrill louvers and wire mesh filters, the overall configuration will be calculated with CFD, a computer simulation software program. This results in the best suitable airflow, pressure loss, low noise levels and minimum build in depth.

The Mist Eliminator can be ordered as an individual solution as well.

SPECIFICATIONS

Max. water load, depending on conditions such as airspeed, 250 grams water per kg air. Droplet separation efficiency, size of smallest droplets that can be separated $\pm 13 \mu\text{m}$ depending on operating air speed.

Width and height specified by customer. Standard units are rectangular. Different shapes are available on request. Installation depth is 149 mm. Practically no maintenance required

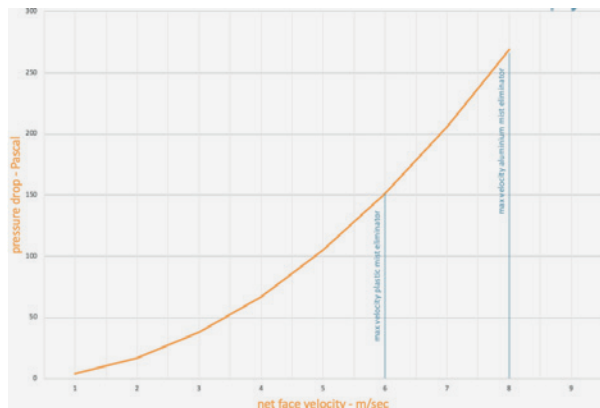

MATERIALS

- Full plastic
- Standard color is black and hardly noticeable behind the grill of an air intake.
- Operating air speed 1 – 6 m/sec.

PERFORMANCE

- Max. water load, depending on conditions such as airspeed, 250 grams water per kg air.
- Droplet separation efficiency, size of smallest droplets that can be separated $\pm 13 \mu\text{m}$ depending on operating air speed.

OPTIONS

- Flange positions and sizes to be specified by the customer. Standard 50 mm.
- Any drain positions can be integrated in the drain-tray (front, back, sides and bottom) Multiple connection types such as bushings, tubes, etc.
- Engineering Fluid Dynamics calculation (EFD)
- Installation on board
- Worldwide shipping
- Annual maintenance / inspection on site
- On site consulting (Refit)

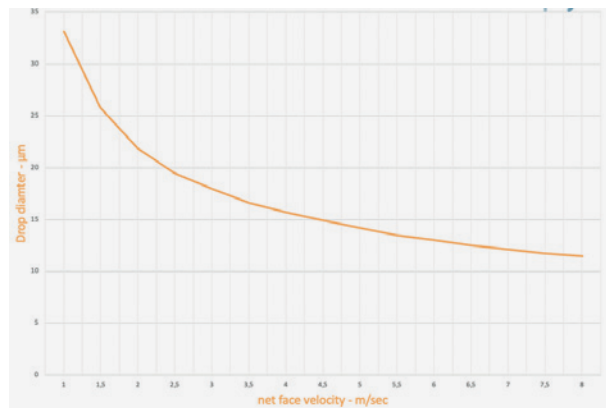
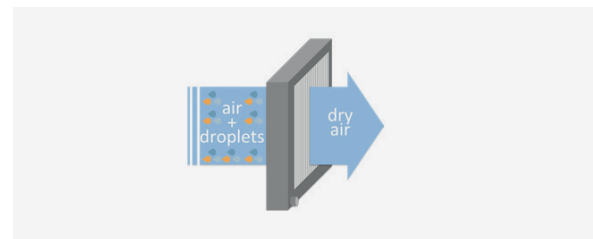

TAILORMADE YACHT SOLUTIONS

SEA OF POSSIBILITIES



BE INSPIRED AT
FLOWGRILL.COM



Functional and stylish tailormade yacht solutions

Handelsdwarstraat 2
6905 DJ Zevenaar
The Netherlands
T: +31 316 23 80 20
E: info@flowgrill.com
W: www.flowgrill.com

FlowGrill presents high-end ventilation louvers and options:



THE OFFICIAL LLOYDS CERTIFICATE OF OUR WEATHERTIGHT SPRAY SHUTTER

The spray shutter is an option behind our ventilation louver which acts as a solid weathertight solution. The spray shutter meets the requirements of the Large Commercial Yacht Code LY2/3 and Section 2.9.2 of the PYC code.



LOUVERS WITH INTEGRATED LED LIGHTING

Design and functionality combined in one of the available FlowGrill louver types. Photo of ceiling louver type SR2500.



ROTATING 'INVISIBLE' LOUVER BLADES

Suitable for many purposes like ventilation and sun shading. The rotating feature creates an invisible design in closed position. With the option 'Glass' it will be an eye catcher on every yacht.

We are looking forward to assist you in your new project.

HIGH QUALITY SURFACE TREATMENTS

PROTECTION AGAINST CORROSION



BE INSPIRED AT
FLOWGRILL.COM



Functional and stylish tailormade yacht solutions

Handelsdwarsstraat 2
6905 DJ Zevenaar
The Netherlands
T: +31 316 23 80 20
E: info@flowgrill.com
W: www.flowgrill.com

Ventilation grills are particularly susceptible to high levels of corrosion when fitted on board luxury superyachts. The combination of airflow, salt water, sunlight and air pollution can be disastrous for grills, and therefore the surface treatment that they receive is one of the most important elements in the production process, second only to smart technical design. FlowGrill, designer and supplier of standard and custom-made products, such as ventilation grills, is continually investing in research to find the highest quality surface treatments.



Prior to the application of paint, one of the best processes to begin with is chemical pre-treatment. This entails submerging the product in three different chemical baths to clean, degrease and apply a conversion layer.

The conversion layer serves as the first layer of protection against corrosion, as well as enabling the first coat of paint to adhere to a clean product. To protect our products even further from the highly corrosive nature of a marine environment, FlowGrill has carried out a salt spray test on a sample product that has been scratched and damaged by hand after having been coated with standard traditional paint. The results show that the surface treatment should never contain any damage or hairline cracks.

TESTING THE THEORY

In collaboration with different international leading companies, FlowGrill has developed a new revolutionary quality improvement: a combination of powder coating and wet paint named the 'hybrid coating system'. This new hybrid coating system consists of several treatments; after the first layer of chemical pre-treatment, the next two layers consist of a special marine powder coating, while the last two layers consist of wet paint, being sure to use the same brand and colour that has been used on the yacht. The new hybrid coating system ensures a decreased sensitivity to damage and cracks due to the layers being

far stronger and durable, as well as achieving a superior level of paint coverage around the edges. In addition, by using powder coatings, hard-to-reach areas now receive the required layer of thickness.

FULL ACCREDITATION

The new paint system has undergone a number of full, accredited tests over the course of four years before ever being applied to products on yachts. The tests were carried out in laboratories by reputable international companies, such as the German company TÜV. A variety of sample tests were carried out using differing conditions to ensure the quality of results.

TEST FACTORS

The main relevant test factors are: the 'Cross Cut' method, which uses a lattice pattern to test the level of separation resistance of paints and coatings layers with regards to substrates; the 'Scratch' test that uses a fine cut made by a knife to test the coating's level of adhesion to substrates; the use of hot wet storage in 40°C and 98% rH to test the level of resistance against humidity; the reproduction of different weather conditions using QUV-A sunlight; the use of water storage to test the level of resistance to liquids; the use of hot dry storage to test the level of discolouration and bleeding of individual layers when exposed to high temperatures; the level of resistance to artificial weathering over the course of 2,000 hours, including chalking, discolouration and loss of gloss; and finally, the 'Salt Spray Test', which tests the level of resistance to corrosion during an aggressive maritime climate over the course of 2,000 hours.

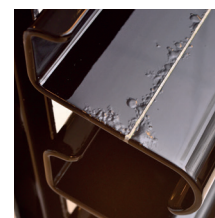

The positive results of this extensive research goes to confirm the new hybrid coating system's suitability for use on luxury yachts, and has proven to be a significant step forward for FlowGrill. In addition, using the new hybrid coating system also helps with the provision of a warranty thanks to its ability to increase a product's lifespan.

SERVICE AND MAINTENANCE

EXTEND THE LIFESPAN OF YOUR LOUVERS



SERVICE AND MAINTENANCE
A carefree process!

FlowGrill provides maintenance services for ventilation grills including the technical options like filters and rotating lamella's for luxury yachts. We help you to minimise disruption and extend the lifetime of your design and functional louver equipment.

FlowGrill's range of services covers maintenance, refit, site inspection, mechanical and electrical equipment repair, on-site repair, testing and preventive maintenance.



Our inspection will locate and fix wear and tear, misalignment, and much more.



WHAT TO EXPECT IN OUR LOUVER MAINTENANCE PACKAGE:

- Full inspection on board of all ventilation positions, including filters, rotating parts, locks, hinges and remaining options.
- Total 'on board' check on damages, alignments, and corrosion.
- Louver adjustment and corrosion control on location.
- Instructions yacht crew on site.
- Quick response and delivery times.
- Various location options (yacht harbour / refit yard)
- Most refit parts on stock.
- Extended warranty options.
- One designated yacht/ refit support contact person.
- Experienced FlowGrill service team, skilled and familiar with yacht- and yard procedures.
- Customer benefits; one stop shopping – one time right - within budget.

All above mentioned can be performed in *Budget* and *Premium Class* execution.

LET US TAKE CARE OF YOUR LOUVERS
CALL +31 316 23 80 20